

Expansion thermometer with microswitch

Temperature limiter

Model SC15

WIKA data sheet TV 28.02



for further approvals,
see page 5

Combistat

Applications

- Large-scale plant
- Baking ovens
- Compressors
- Refrigeration industry

Special features

- Temperature limiter and indicator in a single instrument
- High switching reliability and long service life



Expansion thermometer with microswitch, model SC15

Description

The model SC15 temperature limiter is a thermometer with a remote capillary for on-site display. Switch contacts ensure the simultaneous monitoring of limit values. This limits the temperature over or under a defined value. For this, the switching temperature can either be set via a knob on the window or is already fixed at the factory.

The shifting disk, which is arranged on the pointer shaft, actuates the switching operation at the microswitch when reaching the set switch point.

Specifications

Basic information	
Nominal size in mm [in]	<ul style="list-style-type: none"> ■ 60 [2.3] ■ 80 [3] ■ 100 [4] ■ 72 x 72 [2.8 x 2.8] ■ 96 x 96 [3.8 x 3.8]
Connection design	
BF1	Plain stem (without thread)
BF2	Rotatable threaded connection
BF3	Union nut
BF4	Compression fitting, sliding on stem
SF91 / SV19	Male nut with loose threaded connection
SF91 / SV20	Male nut with sealing cone
SF95	Threaded connection M10 x 1 with compression spring
	Further connection designs on request
Fill fluid	<ul style="list-style-type: none"> ■ Xylene ■ Silicone oil ■ Syltherm
Mounting	<ul style="list-style-type: none"> ■ Panel mounting with mounting bracket ■ Panel mounting flange (only with NS 60 [2.3"], 80 [3"] or 100 [4"])
Material (in contact with the environment)	
Case	<ul style="list-style-type: none"> ■ Plastic, black ■ Sheet steel (for NS 60 [2.3"], 80 [3"] or 100 [4"])
Window	Plastic

Measurement principle	
Type of measurement principle	Bourdon tube system
Remote capillary	
Length	Max. 10 m [39.37 in]
Material (non-wetted)	<ul style="list-style-type: none"> ■ Copper, plastic-coated ■ Copper, copper-braided ■ Stainless steel

Accuracy specifications	
Indication accuracy	Class 2 per EN 13190

Scale range	
Scale ranges	
Remote capillary from copper, plastic-coated	-40 ... +120 °C [-40 ... +248 °F]
Remote capillary from copper, copper-braided	-40 ... +350 °C [-40 ... +662 °F]
Remote capillary from stainless steel	-100 ... +400 °C [-148 ... +752 °F]
Unit (scale range)	<ul style="list-style-type: none"> ■ °C ■ °F ■ °C/°F (dual scale) ■ °F/°C (dual scale)

Scale range		
Dial		
Scale graduation	<ul style="list-style-type: none"> ■ Single scale ■ Dual scale 	
Scale angle	Max. 270 \angle °	
Scale colour	Single scale	Black
	Dual scale	Red
		Other colours on request
Materials	Aluminium, white	
Pointer		
Actual value pointer	Aluminium, black	
Set pointer 1	Aluminium, red	
Set pointer 2	Aluminium, green	

Process connection	
Thread size	<ul style="list-style-type: none"> ■ G ½ B, male thread ■ G ¾ B, male thread ■ G ½, female thread ■ G ¾, female thread ■ M10 x 1, male thread ■ M14 x 1.5, male thread ■ M16 x 1.5, male thread ■ M18 x 1.5, male thread ■ ½ NPT, male thread ■ ¼ NPT, male thread ■ ½ NPT, male thread
Material	<ul style="list-style-type: none"> ■ Copper alloy ■ Stainless steel
Stem	
Diameter	<ul style="list-style-type: none"> ■ 6 mm ■ 8 mm ■ 8.5 mm ■ 10 mm
Material (wetted)	<ul style="list-style-type: none"> ■ Copper alloy ■ Stainless steel 316L
Insertion length l_1	20 ... 600 mm [0.78 ... 23.62 in]
Thermowell	
Thermowell model	<ul style="list-style-type: none"> ■ Without ■ SH16 ■ SB18
Thermowell diameter	<ul style="list-style-type: none"> ■ 8 mm ■ 10 mm
Insertion length U_1	20 ... 600 mm [1.18 ... 23.62 in]

Output signal	
Type of contact	Microswitch
Contact version	<ul style="list-style-type: none"> ■ 1 adjustable change-over contact ■ 2 adjustable change-over contacts ■ 2 jointly adjustable change-over contacts ■ 1 adjustable and 1 fixed change-over contact ■ 1 fixed change-over contact ■ 2 fixed change-over contacts
Switch rating	<ul style="list-style-type: none"> ■ 5 A non-inductive at max. 250 V, 50 ... 60 Hz ■ 10 A non-inductive at max. 250 V, 50 ... 60 Hz
Switching power	cos φ = 1 (0.6)
Operating principle per EN 60730-1	Type 1.B Integrated RS Temperature limiter
Number of switching cycles per EN 60730-1	10,000 (for UL version 6,000)
Standard switch differential	< 2 % of measuring range
Switch point setting	<ul style="list-style-type: none"> ■ Knob ■ Knob with key adjustment





Electrical connection	
Connection type	<ul style="list-style-type: none"> ■ 0.8 x 6.3 mm [0.03 x 0.25 in] blade terminal per DIN 46244 ■ Terminal connection with conductor cross-section up to 1.5 mm²

Operating conditions	
Ambient temperature range	0 ... 50 °C [32 ... 122 °F]
Storage and transport temperature range	-40 ... +60 °C [-40 ... +140 °F]
Ingress protection (IP code) per IEC/EN 60529	<ul style="list-style-type: none"> ■ Front: IP53; Rear: IP00 ■ With protective cap: IP54

Approvals

Logo	Description	Country
	UL Component certification	USA and Canada

Optional approvals

Logo	Description	Country
	EAC	Eurasian Economic Community
	EMC directive	
	Low voltage directive	
	PAC Russia Metrology, measurement technology	Russia
	PAC Kazakhstan Metrology, measurement technology	Kazakhstan
-	MChS Permission for commissioning	Kazakhstan
	PAC Ukraine Metrology, measurement technology	Ukraine
	PAC Uzbekistan Metrology, measurement technology	Uzbekistan
-	CRN Safety (e.g. electr. safety, overpressure, ...)	Canada

Certificates (option)

Certificates	
Certificates	<ul style="list-style-type: none"> ■ 2.2 test report ■ 3.1 inspection certificate with 3 test points (optionally with 5 test points)

For approvals and certificates, see website

Connection design

BF1, plain stem (without thread)

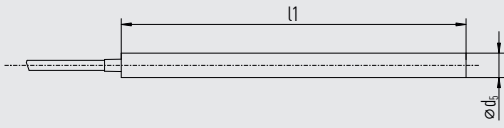

BF2, rotatable threaded connection

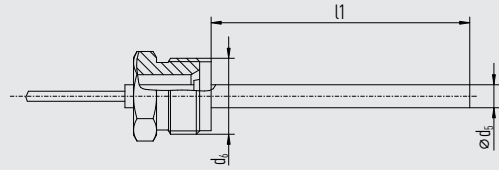

BF3, union nut

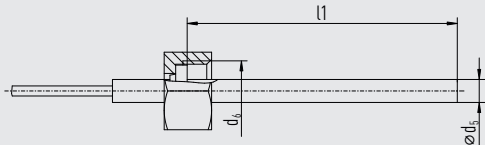

Design 4, compression fitting, sliding on stem

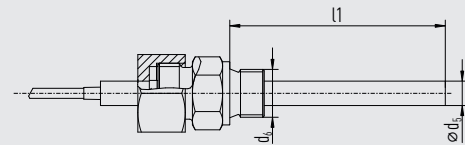

SF91/SV19, male nut with loose threaded connection

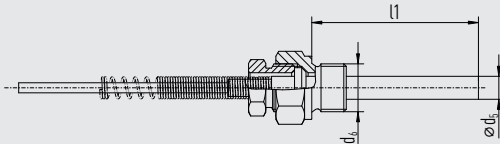

SF91/SV20, male nut with sealing cone

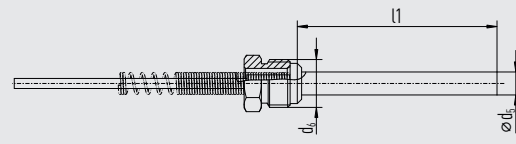

SF95, threaded connection M10 x 1 with compression spring

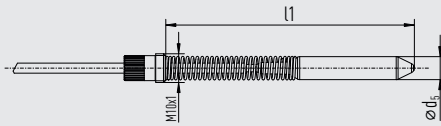

Legend:

$\varnothing d_5$ Stem diameter

$\varnothing d_6$ Threaded process connection

l_1 Variable insertion length

With mounted thermowell

SV20 with thermowell SH16

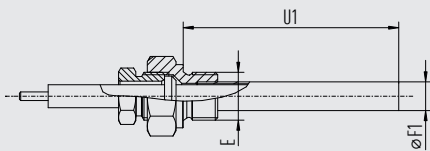

SF95 with thermowell SB18

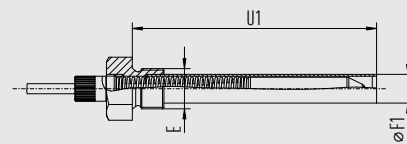

Legend:

$\varnothing F_1$ Thermowell diameter

E Threaded process connection

U_1 Variable insertion length

Dimensions in mm [in]

NS 60 [2.3"], plastic with 1 contact

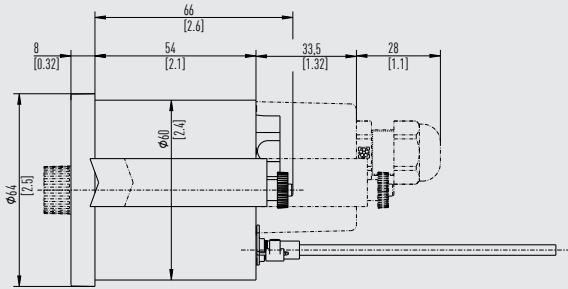

11367041.03

NS 60 [2.3"], plastic with 2 contacts

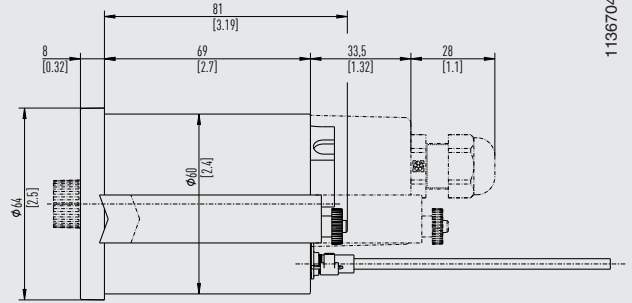

11367041.03

NS 80 [3"]/NS 100 [4"], plastic

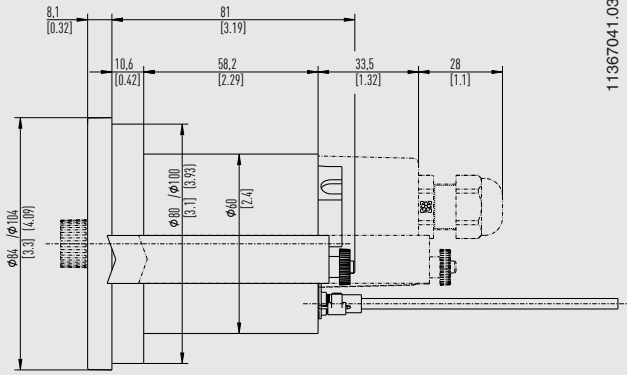

11367041.03

NS 60 [2.3"], sheet steel

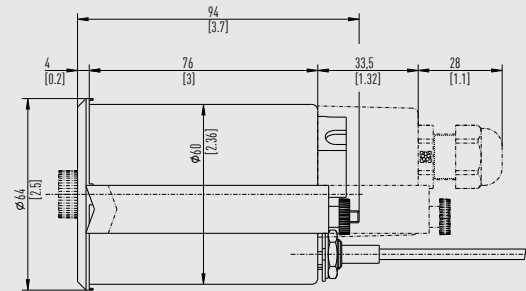

14311361.01

NS 80 [3"], sheet steel

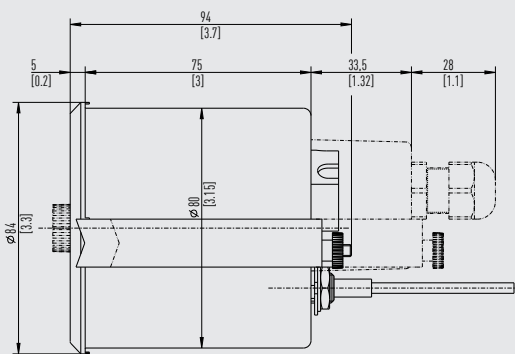

14311361.01

NS 100 [4"], sheet steel

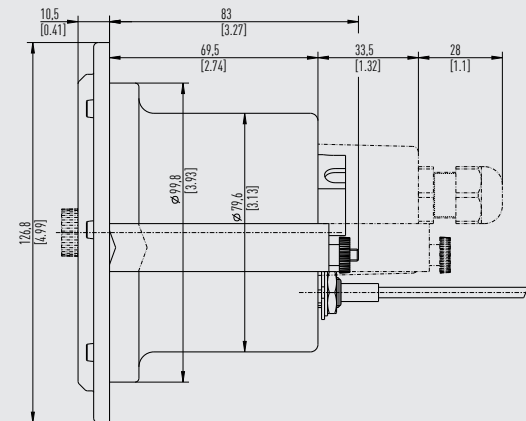

14311361.01

Front mounting

NS 60 [2.3"]

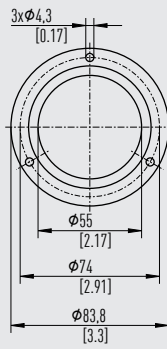

NS 80 [3"]

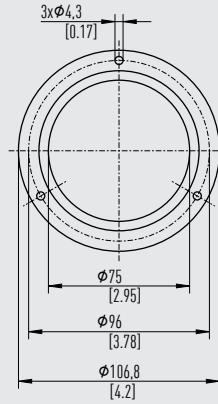

NS 100 [4"], sheet metal

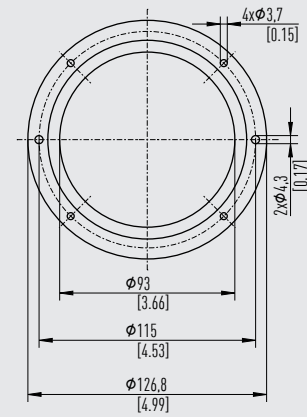

11367016.03

Ordering information

Model / Nominal size / Scale range / Contact version / Switch points / Remote capillary / Remote capillary length / Connection design / Options

© 05/2008 WIKA Alexander Wiegand SE & Co. KG, all rights reserved.
The specifications given in this document represent the state of engineering at the time of publishing.
We reserve the right to make modifications to the specifications and materials.

